



cast silver: 40433



canvas flax: 5492



canvas navy: 5439

charcoal: NC-S-(cushion code)-CG



black:
NC-S-(cushion code)-BL



cloud:
NC-S-(cushion code)-CW



leaf:
NC-S-(cushion code)-LG

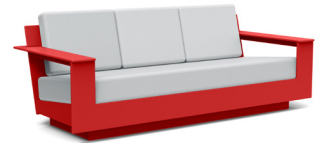

apple red:
NC-S-(cushion code)-AR

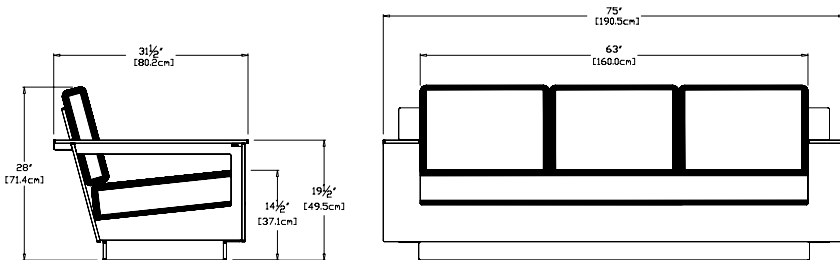

driftwood:
NC-S-(cushion code)-DW



navy blue:
NC-S-(cushion code)-NB

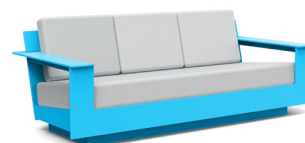

sky:
NC-S-(cushion code)-SB



sunset:
NC-S-(cushion code)-OR

collection: nisswa
material: 100% recycled HDPE
dimensions: width: 75" (190.5cm)
 depth: 31.5" (80.2cm)
 height: 28" (71.4cm)
weight: 106 lbs (48.2kg)



672
reclaimed
milk jugs



ships fully assembled

shipping: Pallet



nisswa lounge chair



cast silver: 40433



canvas flax: 5492



canvas navy: 5439

charcoal: NC-L-(cushion code)-CG



black:
NC-L-(cushion code)-BL



cloud:
NC-L-(cushion code)-CW



leaf:
NC-L-(cushion code)-LG



apple red:
NC-L-(cushion code)-AR



driftwood:
NC-L-(cushion code)-DW



navy blue:
NC-L-(cushion code)-NB



sky:
NC-L-(cushion code)-SB



sunset:
NC-L-(cushion code)-OR

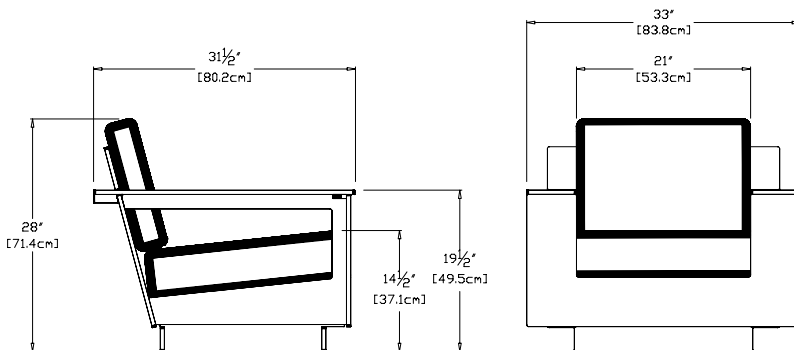

collection: nisswa
material: 100% recycled HDPE
dimensions: width: 33" (83.8cm)
 depth: 31.5" (80.2cm)
 height: 28" (71.4cm)
weight: 53 lbs (24.1kg)



360
reclaimed
milk jugs

shipping: Pallet



ships fully assembled



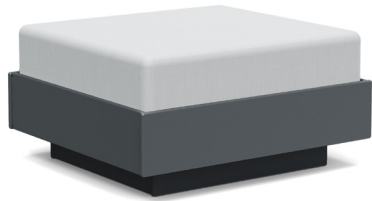

cast silver: 40433



canvas flax: 5492

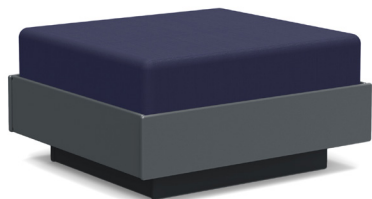

canvas navy: 5439

charcoal: NC-O-(cushion code)-CG

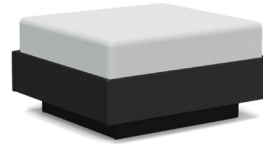

black:
NC-O-(cushion code)-BL



cloud:
NC-O-(cushion code)-CW

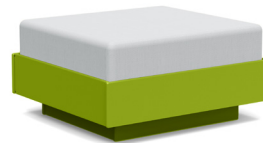

leaf:
NC-O-(cushion code)-LG

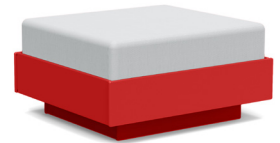

apple red:
NC-O-(cushion code)-AR

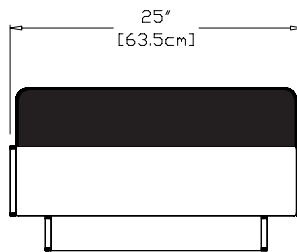
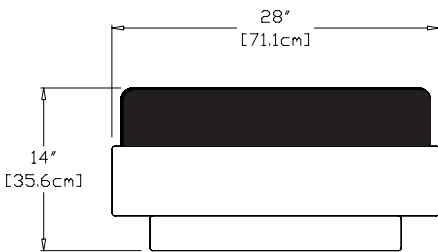

driftwood:
NC-O-(cushion code)-DW

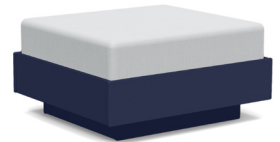

navy blue:
NC-O-(cushion code)-NB

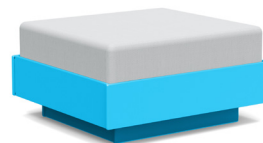

sky:
NC-O-(cushion code)-SB



sunset:
NC-O-(cushion code)-OR

collection: nisswa
material: 100% recycled HDPE
dimensions: width: 33" (83.8cm)
 depth: 31.5" (80.2cm)
 height: 28" (71.4cm)
weight: 30 lbs (13.6kg)



200
reclaimed
milk jugs

shipping: Pallet



ships fully assembled

