

## INCLUDED PARTS

### Keene Lounge Chair

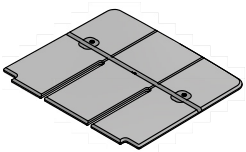

P2  
1x

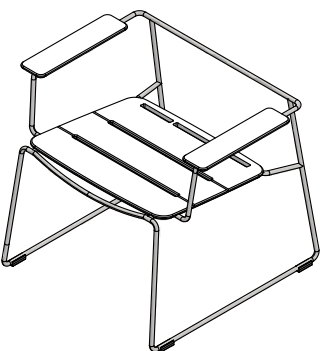

P1  
1x

### Keene Dining Chair

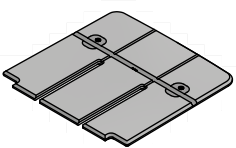

P2  
1x

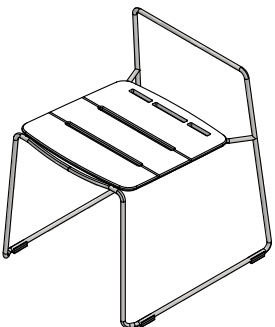

P1  
1x

### Keene Bar Stool

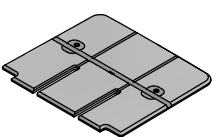

P2  
1x

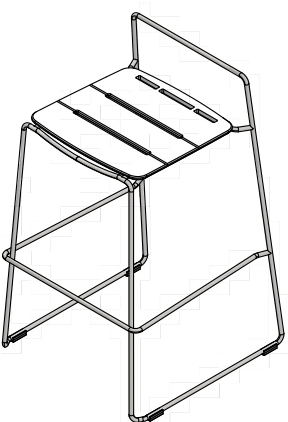

P1  
1x

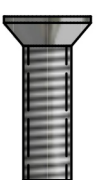

7/8"  
2x

\*Bolt shown actual size.

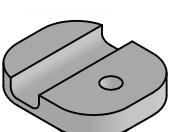

Keene Block  
2x

## ASSEMBLY TIPS: 5 Important Points You NEED to Read

1. Prior to beginning assembly, please inspect and inventory the parts to make sure you have everything and that nothing was damaged during shipping. If damage has occurred, please take photos and go to [lollidesigns.com/damage](http://lollidesigns.com/damage). Rest assured we'll get it taken care of straight away!
2. To avoid scratching furniture, assemble on a clean, soft surface like a blanket, carpet, or the flattened cardboard box the furniture was shipped in.
3. **Start all bolts by hand to ensure proper alignment and to prevent cross threading.** Then using the provided tool, tighten until you feel resistance. Do not overtighten.
4. Bolts should not be forced, but some components, particularly blocks, fit snug but can still be installed without tools or excess force.
5. If parts are still not going together, please send us a photo of the part you are having trouble with.

## BLOCK & BOLT INSTALLATION

Insert bolts through countersunk hole side of blocks as shown below.

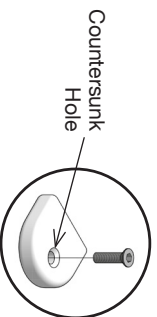

CORRECT

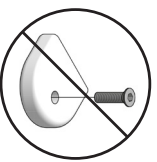

INCORRECT

*"Loll Designs inspires people to appreciate the outdoors."*

Greg Benson - Founder

## ♻️ RECYCLE THE PACKAGING

We've gone through great lengths to make as much of our packaging as possible recyclable. The cardboard box, paper wrap, filler and paper bags can all go in your recycling bin. The muslin hardware bags replaced plastic bags with the intention of reducing plastic and encouraging reuse. Loll Designs and Planet Earth thank you!

## WE WANT YOU TO LOVE YOUR LOLL

For more info and visual aids, watch the assembly videos at [www.lollidesigns.com/videos](http://www.lollidesigns.com/videos). For product care & maintenance, visit [www.lollidesigns.com/care-maintenance](http://www.lollidesigns.com/care-maintenance). For further lollygagging assistance, please reach out!

+1 877-740-3387

[sales@lollidesigns.com](mailto:sales@lollidesigns.com)

5912 Waseca Street  
Duluth, Minnesota 55807

## ASSEMBLY INSTRUCTIONS & PRODUCT INFO:

## KEENE CHAIRS

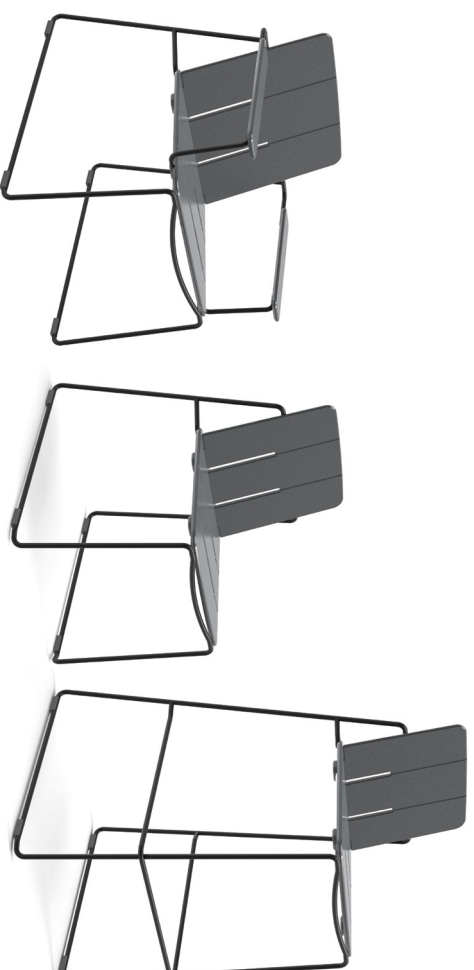

LOLL  
DESIGNS

MADE IN THE USA



1

\*Dining Chair is shown in instructions.

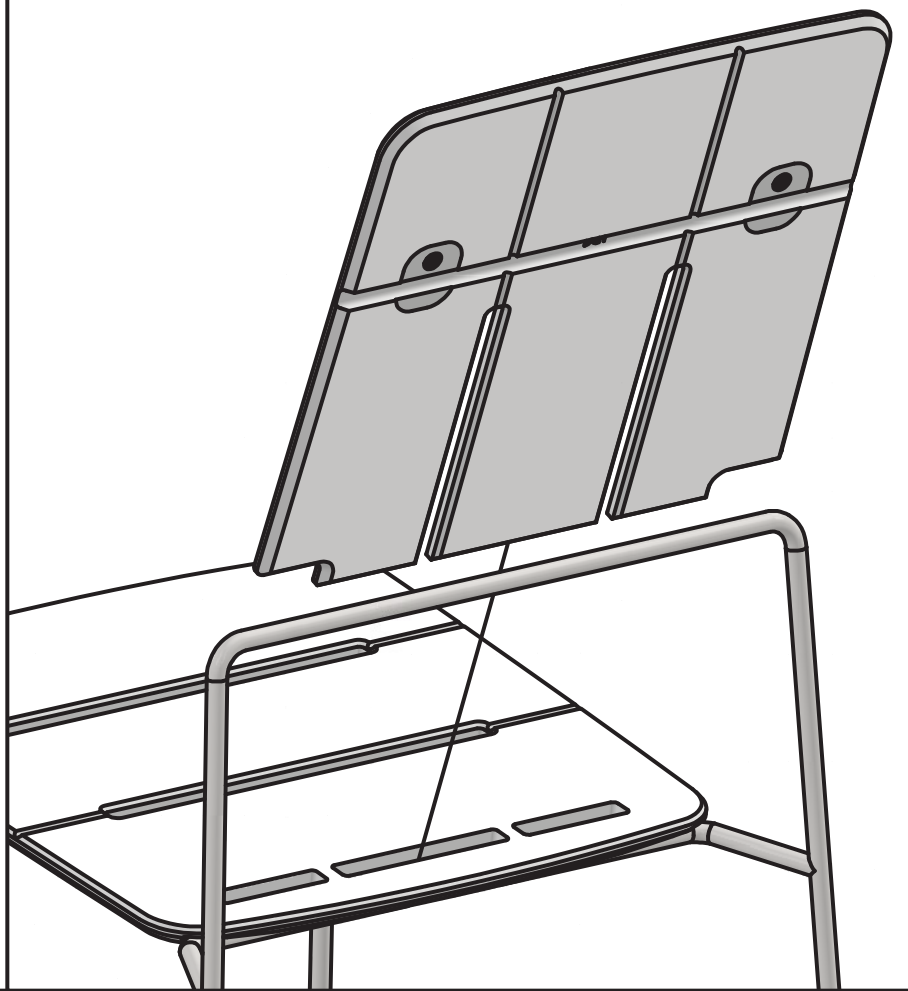
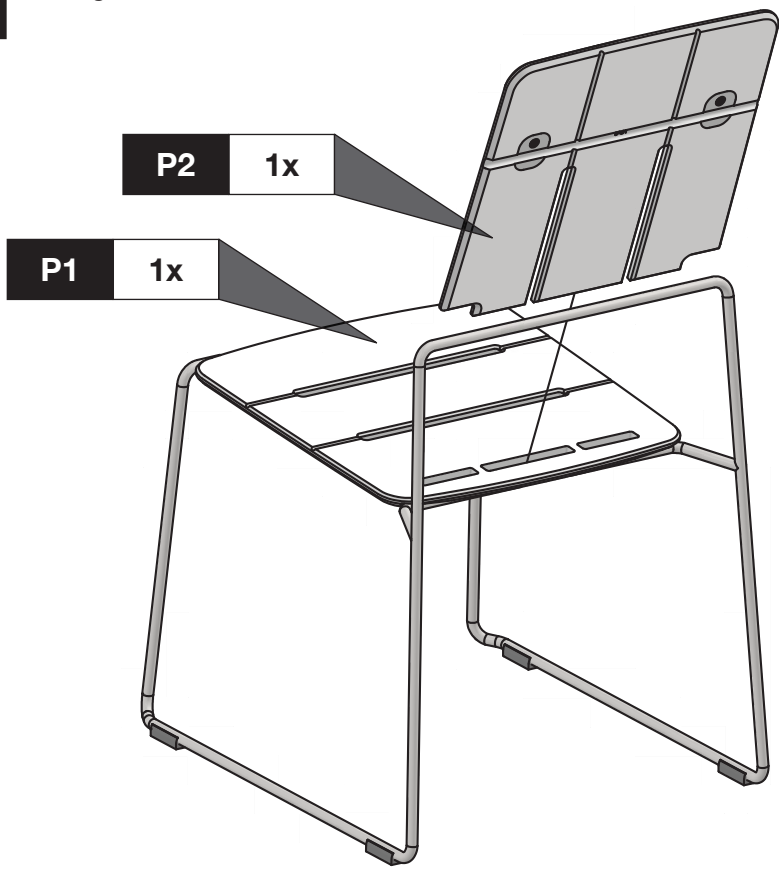

2

Keene Block 2x

