

INCLUDED PARTS

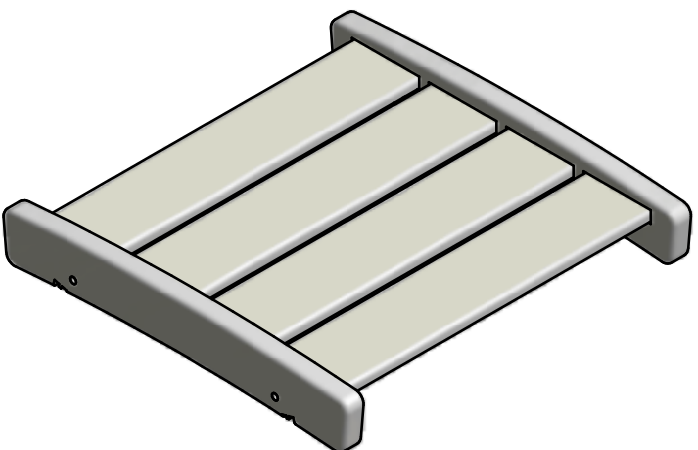

TOP ASSEMBLY
1x

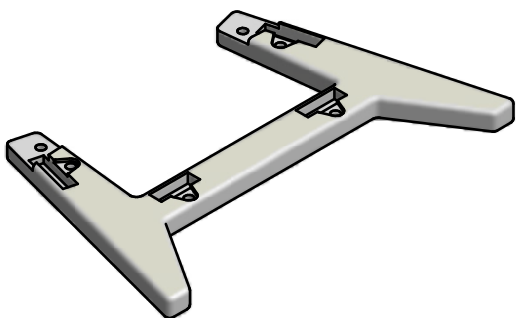

P1
2x

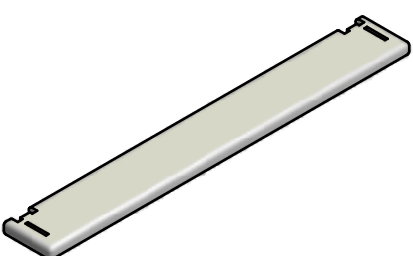

P3
2x

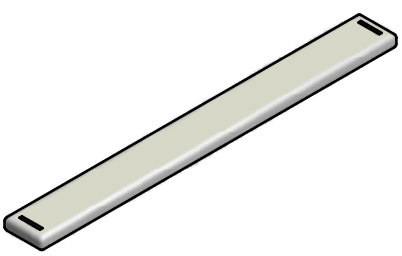

P4
2x

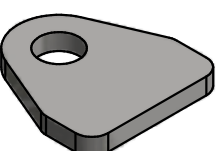

MB
8x



1/2"
8x

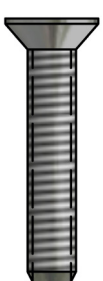

1 3/8"
4x

*Bolts & Tools shown actual size.

ASSEMBLY TIPS

**Please read before beginning assembly!*

To avoid damaging furniture perform the assembly of your Loll furniture on a clean soft surface like a blanket, carpet, or the flattened cardboard box the furniture was shipped in. Components should not be unnecessarily forced together! If it seems parts aren't fitting together you likely have something wrong and you should reread the instructions to ensure you are aligning the proper components. If your piece of furniture requires "Blocks" for assembly one side may have protective film on it. This surface is hidden after assembly so the film can remain on the block or it can be removed. Use a Cordless Screw Gun if you have one and know how to use it. Set the clutch setting at medium torque. We do not recommend using an electric drill with a cord and without a clutch to install bolts in inserts as you can easily overtighten and damage the product. All bolts come standard with a thread coating to reduce bolts loosening after assembly while still allowing removal and reuse of the bolt. Start all bolts by hand, with the Allen Key, or the Loll Tool and tighten firmly until parts are drawn tight together and you can't muscle the bolt any tighter. It's virtually impossible to over tighten by hand. Watch the assembly videos at www.lolldesigns.com/videos for even more information and visual aids. If you have more questions please contact your Loll Sales Associate or Customer Service for support at 877.740.3387. A **Pro Tool Kit** can also be purchased from Loll for multi piece assembly jobs.

Scan for assembly tips and videos



BLOCK & BOLT INSTALLATION

Insert bolts through countersunk hole side of blocks as shown below.

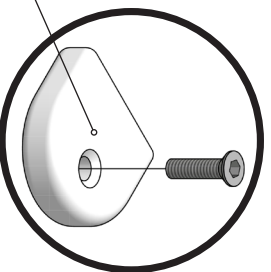

CORRECT

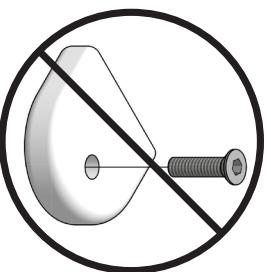

INCORRECT

LOLL TOOL

Locate the box marked "Tool Included" before beginning assembly.



PRODUCT CARE

Your new Loll furniture is a no maintenance product. You'll never need to paint or stain it and it can be left outside all year regardless of the season. It will not rot, even if left standing in water. Nonetheless, we're pretty sure your Loll furniture will get a lot of use and will at some point need cleaning. We recommend a garden hose and incorporating a soft bristle brush. Adding a tablespoon or two of your favorite eco-friendly soap to the wash will get everything squeaky clean. Mineral deposits left over from hard water can be removed with a solution of vinegar and water. Loll offers a cleaning kit that has everything you need for great results. Also see our cleaning video at lolldesigns.com/videos.

5 YR WARRANTY

Loll Designs strives to build long-term relationships based on confidence and trust with our customers. We sit beside, on top, and beneath the quality of our fine furniture and will make things right if you are not completely satisfied with your purchase. Loll Designs hereby guarantees that the piece will be of good quality and workmanship, free from faults and defects. Loll warrants that all components will not fail, under normal use, for five years from the year mark on the piece or the date of purchase. *For commercial orders the warranty is three years.

DAMAGED PRODUCT

Sometimes accidents occur. Please inspect your Loll furniture when you receive it to make sure that it has not been damaged during shipping. If damage has occurred please take digital pictures of the damaged furniture and the box it was shipped in, and email them to sales@lolldesigns.com or call Customer Service using our toll free number: 877.740.3387, ext. 1. The damage will be assessed and you will be contacted with a solution to the problem. It may be helpful to save all of your packaging material in case a return is necessary.

We want you to love your Loll.

Reach out if you need lollygagging assistance.

877-740-3387

sales@lolldesigns.com

5912 Waseca Street | Duluth, Minnesota 55807

MADE IN THE USA



SHARE YOUR LOLL

ASSEMBLY INSTRUCTIONS & PRODUCT INFO:

RAPSON OTTOMAN

Loll Designs inspires people to appreciate the outdoors.

lolldesigns.com
877.740.3387



LOLL
DESIGNS

